

pompe everflo



everflo

 **COMET**
AGRICULTURAL DIVISION



POMPE EVERFLO



EF 1200



EF 2200



EF 3000



EF 4000



EF 5500 - 12V



EF 5500 - 24V



EF 7000 - 12V



EF 7000 - 24V

Petite pulvérisation et traitement de désherbage entre les files, jardinage, hygiène et nettoyage de caravanes et bateaux, traitement d'espaces verts, assainissement de véhicules et de fermes agricoles.

CARACTÉRISTIQUES TECHNIQUES

POMPE

- Axiale à membrane avec plusieurs éléments de pompage
- Auto-amorçante
- Fonctionne à sec sans provoquer de dommages
- Équipée d'un micro-interrupteur Honeywell® qui arrête le moteur quand on ferme le refoulement et empêche que la pression maximale soit dépassée
- Résistante au pompage des produits chimiques, grâce aux matériaux utilisés
- Corps en Polypropylène
- Vannes d'aspiration et de refoulement en Viton®
- Membranes Santoprène®
- Vis et éléments de fixation en Acier galvanisé
- Compatibles avec les additifs AdBlue® et BlueDEF® pour les véhicules lourds à moteur diesel.

MOTEUR

- Alimentation en Courant Continu 12-24V
- Fabrication à aimants permanents
- Carcasse en acier peint
- Protection thermique à fusible externe



EF 1200

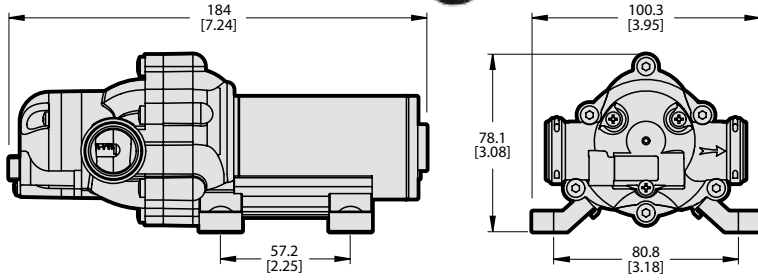

3,8 l/min - 1.0 gpm

bar	psi	MPa	l/min	gpm	A
0,5	7	0	3,8	1,0	1,8
1,0	15	0,10	3,4	0,9	2,2
1,5	22	0,15	3,0	0,8	2,5
2,0	29	0,20	2,6	0,7	2,8
2,5	36	0,25	2,2	0,6	3,0
2,7	40	0,27	2,0	0,5	3,1

EF 2200

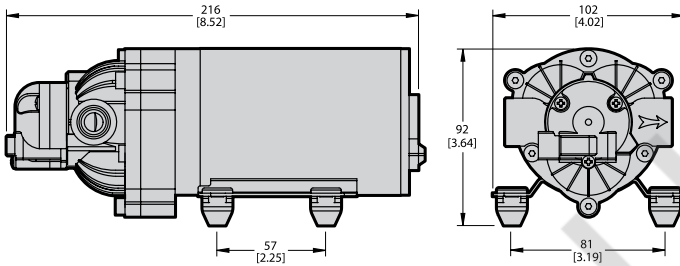

8,3 l/min - 2.2 gpm

bar	psi	MPa	l/min	gpm	A
0,5	7	0	8,3	2,2	4,2
1,0	15	0,10	7,6	2,0	4,7
1,5	22	0,15	7,2	1,9	5,3
2,0	29	0,20	6,7	1,8	5,8
2,5	36	0,25	6,2	1,6	6,4
3,0	44	0,30	5,9	1,6	6,8
3,5	51	0,35	5,6	1,5	7,3
4,1	59	0,41	5,1	1,3	7,8
4,8	70	0,48	-	-	-

EF 3000

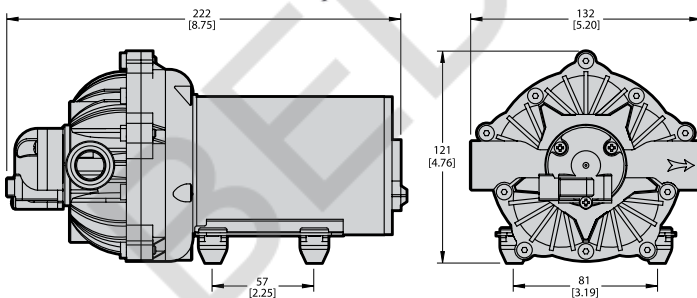

11,4 l/min - 3.0 gpm

bar	psi	MPa	l/min	gpm	A
0,5	7	0,05	11,4	3,0	5,0
1,0	15	0,10	10,7	2,8	6,3
1,5	22	0,15	10,0	2,6	7,2
2,0	29	0,20	9,3	2,5	8,0
2,5	36	0,25	8,5	2,2	8,6
3,0	44	0,30	7,8	2,1	9,2
3,4	49	0,34	7,0	1,8	10,0
4,1	59	0,41	-	-	-

EF 4000

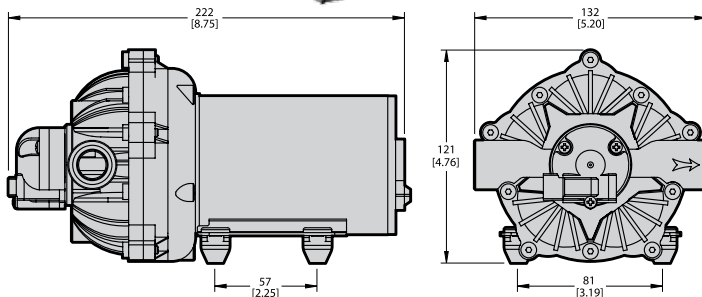

15,1 l/min - 4.0 gpm

bar	psi	MPa	l/min	gpm	A
0,5	7	0,05	15,1	4,0	6,0
1,0	15	0,10	14,3	3,8	7,6
1,5	22	0,15	13,6	3,6	8,9
2,0	29	0,20	12,8	3,4	10,0
2,5	36	0,25	12,0	3,2	11,0
3,0	44	0,30	11,3	3,0	12,0
3,4	49	0,34	10,5	2,8	12,7
4,1	59	0,41	-	-	-

EF 5500 - 12V

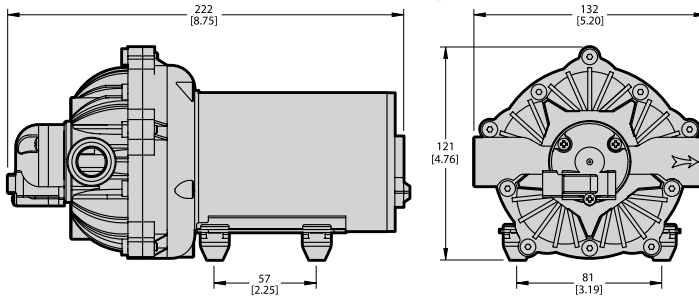

20,8 l/min - 5.5 gpm

bar	psi	MPa	l/min	gpm	A
0,5	7	0,05	20,8	5,5	10,0
1,0	15	0,10	19,8	5,2	11,0
1,5	22	0,15	19,0	5,0	12,3
2,0	29	0,20	18,0	4,8	13,5
2,5	36	0,25	17,0	4,5	15,0
3,0	44	0,30	16,3	4,3	15,8
3,4	49	0,34	15,2	4,0	16,8
4,1	59	0,41	-	-	-

EF 5500 - 24V

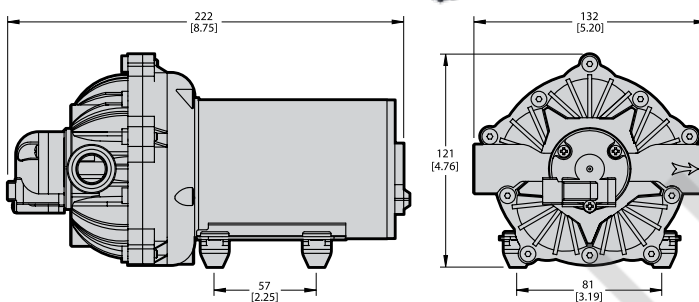

20,8 l/min - 5.5 gpm

bar	psi	MPa	l/min	gpm	A
0,5	7	0,05	20,8	5,5	3,5
1,0	15	0,10	19,8	5,2	4,3
1,5	22	0,15	19,0	5,0	4,9
2,0	29	0,20	18,0	4,8	5,6
2,5	36	0,25	17,0	4,5	6,3
3,0	44	0,30	16,3	4,3	7,0
3,4	49	0,34	15,2	4,0	7,5
4,1	59	0,41	-	-	-

EF 7000 - 12V

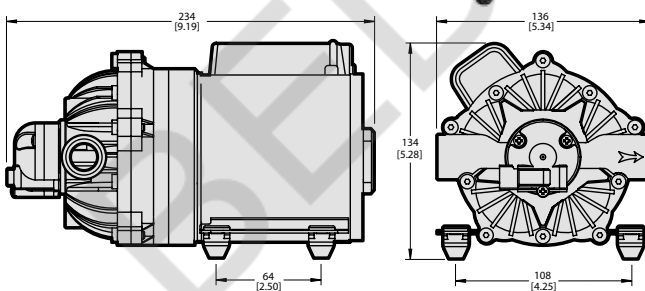

26,5 l/min - 7.0 gpm

bar	psi	MPa	l/min	gpm	A
0,5	7	0,05	26,5	7,0	11,5
1,0	15	0,10	24,9	6,6	13,0
1,5	22	0,15	24,0	6,3	14,3
2,0	29	0,20	22,8	6,0	15,7
2,5	36	0,25	21,8	5,8	17,3
3,0	44	0,30	20,5	5,4	18,7
3,4	49	0,34	19,7	5,2	20,0
4,1	59	0,41	-	-	-

EF 7000 - 24V

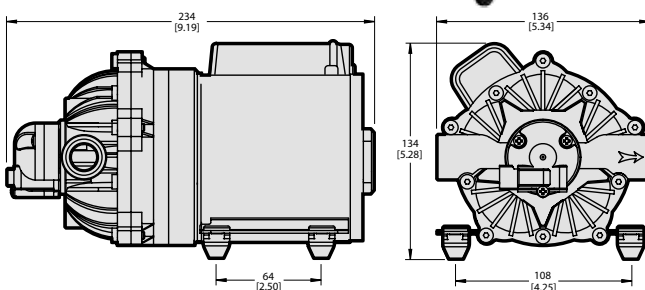

26,5 l/min - 7.0 gpm

bar	psi	MPa	l/min	gpm	A
0,5	7	0,05	26,5	7,0	5,0
1,0	15	0,10	24,9	6,6	5,7
1,5	22	0,15	24,0	6,3	6,6
2,0	29	0,20	22,8	6,0	7,4
2,5	36	0,25	21,8	5,8	8,2
3,0	44	0,30	20,5	5,4	8,9
3,4	49	0,34	19,7	5,2	9,5
4,1	59	0,41	-	-	-

ACCESSOIRES EVERFLO



1204 0582 *

Vanne de régulation de la pression avec By-pass et levier de déchargement rapide (avec manomètre)



1204 0583 *

Vanne de régulation de la pression avec By-pass et levier de déchargement rapide (sans manomètre)



8001 0049 *

Groupe de commande 2 voies

* Excepté pour les modèles EF1000 - EF2200

8001 0162

Régulateur de pression
7 BAR 27 L/M 50°C



8001 0169

Raccord rapide F - 3/8" M



8001 0170

Épingle



8001 0163

Raccord rapide M -
cannelé 10 mm



8001 0164

Raccord rapide M -
cannelé 13 mm



8001 0165

Raccord rapide M -
cannelé 19 mm



8001 0166

Raccord rapide coudé M -
cannelé 10 mm



8001 0167

Raccord rapide coudé M -
cannelé 13 mm



8001 0168

Raccord rapide M - 1/2" M



8001 0171

Réduction 1/2" M NPT - 3/8" F



ACCESSOIRES EVERFLO

8001 0051

Kit câble avec interrupteur et pinces



8001 0054

Régulateur de pression E-1/2" - S-3/4"



8001 0052

Kit câble avec interrupteur et prise allume cigare



8001 0053

Manomètre D 50 - 7 BAR - 1/4" M



8001 0157

Raccord coudé 3/8" M - cannelé 11 mm



8001 0156

Raccord droit 3/8" M - cannelé 11 mm



8001 0155

Raccord coudé 1/2" M - cannelé 11 mm



8001 0158

Raccord droit 1/2" M - cannelé 13 mm



8001 0159

Raccord coudé 1/2" M - cannelé 13 mm



2800 0002

Raccord droit 3/8" M - cannelé 19 mm



8001 0154

Té 1/2" FFF + 1/4" F manomètre



8001 0044

Bouchon 1/4" F



EMBALLAGE



pompes everflo

COMET FRANCE › Wolfisheim › France › mail@cometfrance.com › www.cometfrance.com

Suivez nous sur



COMPANY
WITH QUALITY SYSTEM
CERTIFIED BY DNV
= ISO 9001/2008 =

Scannez pour plus d'information



Comet, Italian Excellence

